

Forensics Brasil

SOLUÇÕES TECNOLÓGICAS EM SEGURANÇA



MALETAS EXCLUSIVAS EM POLIPROPILENO

Forensics Brasil

SOLUÇÕES TECNOLÓGICAS EM SEGURANÇA

Maletas Modelo MLC

Desenvolvidas para equipamento de campo



Otimize seu processo produtivo e ganhe em qualidade!

Foi pensando na sua praticidade dos nossos clientes que desenvolvemos as malas modelo MLC para adequar seus equipamentos de campo.

As malas podem ser fornecidas com ou sem logotipia.

Elimine uma etapa do seu processo produtivo e ganhe em qualidade.

Consulte nosso departamento de vendas e saiba mais!





Características

- Desenvolvida especialmente para uso em campo
- Com estrutura robusta é um produto altamente resistente e leve;
- O acabamento refinado e Design arrojado valorizam cada detalhe de produto;
- Os fechos com travamento duplo são simples e fáceis de abrir, garantem um travamento sob alta pressão e impedem a abertura ocasional do sistema;
- A criação de uma saída especial de ar permite a despressurização da mala e facilita a sua abertura;
- Todos os pinos e encaixes são precisos e garantem a proteção ideal contra pó e água para transporte do seu equipamento;

MODELO MLC20



Tamanho exterior: 210 x 93 mm

Tamanho interno: 148 x 148 mm

Tampa / Profundidade:

Peso Sem Esponja:

Material: Termoplástico de Engenharia

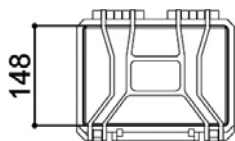
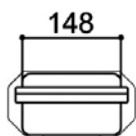
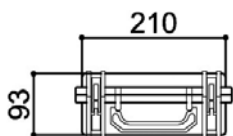

Cores disponíveis do produto (sob consulta):



MODELO MLC25



Tamanho exterior: 258 x 120 mm

Tamanho interno: 205 x 205 mm

Tampa / Profundidade:

Peso Sem Esponja:

Material: Termoplástico de Engenharia

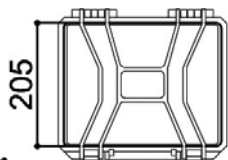
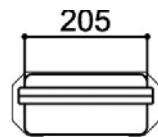
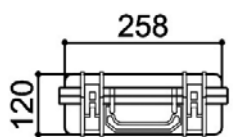

Cores disponíveis do produto (sob consulta):



MODELO MLC35



Tamanho exterior: 365 x 162 mm
Tamanho interno: 273 x 273 mm
Tampa / Profundidade:
Peso Sem Esponja:
Material: Termoplástico de Engenharia

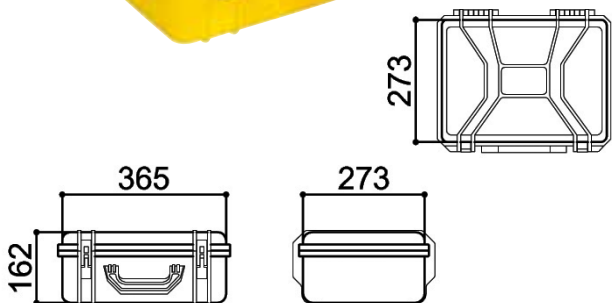

Cores disponíveis do produto (sob consulta):



MODELO MLC50



Tamanho exterior: 493 x 184 mm
Tamanho interno: 363 x 363 mm
Tampa / Profundidade:
Peso Sem Esponja:
Material: Termoplástico de Engenharia

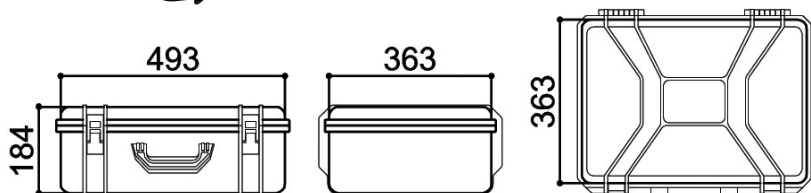

Cores disponíveis do produto (sob consulta):



MODELO MLC55



Tamanho exterior: 210 x 93 mm

Tamanho interno: 148 x 148 mm

Tampa / Profundidade:

Peso Sem Esponja:

Material: Termoplástico de Engenharia

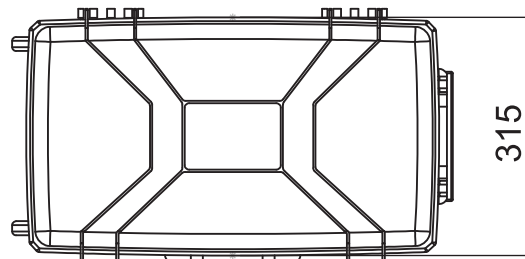
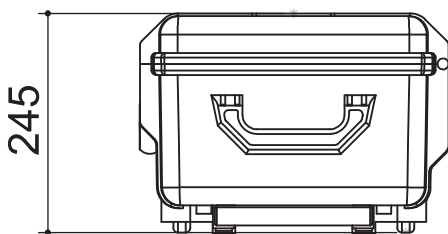
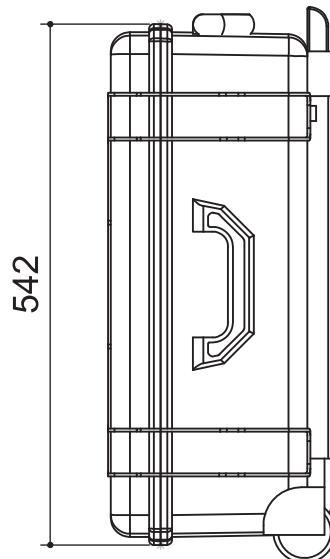

Cores disponíveis do produto (sob consulta):



Cores disponíveis do produto (sob consulta):

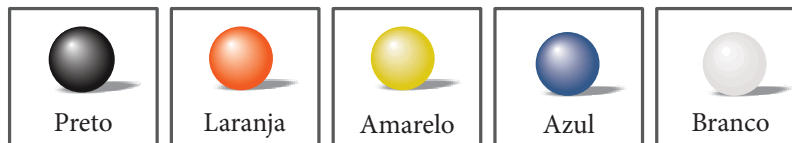

Entre em contato para maiores informações:

Forensics Brasil

Rua Nove de Julho, 72 - Torre Norte, Sala 123

04739-010 - Santo Amaro, São Paulo - SP

(11) 4210-0190

vendas@forensicsbrasil.com.br

www.forensicsbrasil.com.br